

分光测色仪 使用说明书

产品介绍

使用产品前请仔细阅读本说明书,并妥善保管

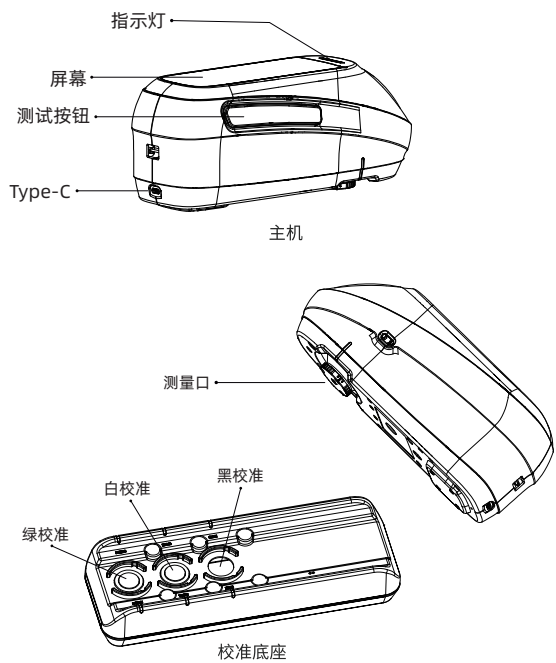

快速使用教程

1. 开机及校准



2. 如何测色差

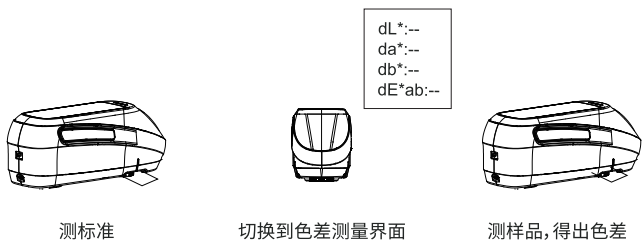

3. 口径切换

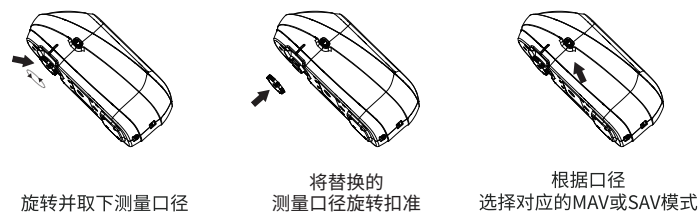

4. 关机

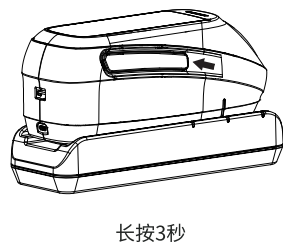

基础参数

NetProf网络校正	支持
测量结构※	D/8,SCI+SCE
SCI+SCE同时测量	支持
积分球直径	40mm
照明光源	全波段均衡LED光源+氙灯
感应器	双列高精度CMOS阵列传感器
校准方式	BCRA认证黑、白板能量校准, 绿板波长准确性校准
分光方式	光栅
显示精度	0.01
光源寿命	1000万次
波长范围	360-780nm
波长间隔	10nm
反射率测定范围	0-200%
反射率分辨率	0.01%
口径	Φ11mm,Φ10mm,Φ6mm,Φ3mm
测量重复性※※	dE*ab≤0.01
台间差※※※	dE*ab≤0.2
UV光源	有
视场角	2°, 10°
光源条件	A,B,C,D50,D55,D65,D75F1,F2,F3,F4,F5,F6,F7,F8,F9,F10,F11,F12CW F,U30,U35,DLF,NBF,TL83,TL84,ID50,ID65,LED-B1,LED-B2,LED-B3,L ED-B4LED-B5,LED-BH1,LED-RGB1,LED-V1,LED-V2
测量指标	光谱反射率,CIE-Lab,CIE-LCh,HunterLab,CIE-Luv,XYZ,Yxy,RGB色差 (ΔE*ab,ΔE*cmc,ΔE*94,ΔE*00),白度(ASTM E313-00,ASTME313-73,CIE,ISO2470/R457,AATCC,Hunter,TaubeBerger Stensby),黄度(ASTM D1925,ASTM E313-00,ASTM E313-73)黑度(My,dM),沾色牢度,变色牢度,Tint(ASTM E313-00)色密度CMYK(A,T,E,M),同色异谱指数MilM,孟塞尔,遮盖力,力份(染料强度,着色力)
测量时间	约1秒
存储	仪器: 10000条; APP: 海量存储
电池容量	单次充电可连续测量8000次, 7.2V/3000mAh
测量观察方式	摄像头
屏幕	全彩屏幕, 3.5英寸
语言	简体中文, 英语
接口	USB, 蓝牙
校准	智能自动校准
软件支持	Andriod,iOS,Windows,微信小程序
准确性保证	保证一级计量合格
符合标准	CIE No.15,GB/T 3978,GB 2893,GB/T 18833,ISO7724-1,ASTM E1164,DIN5033 Teil7
尺寸	233mm*77mm*93mm
重量	约600g

※ 漫射照明/8°方向接收, 包含镜面反射光/去除镜面反射光
 ※※ 白板校准后以5秒间隔测量白板30次以MAV口径测量结果标准偏差
 ※※※ BCRA系列12块色板MAV口径测量值的平均值

保修说明

本产品售后服务严格依据《中华人民共和国消费者权益保护法》、《中华人民共和国产品质量法》实行售后三包服务,服务内容如下:

- 1、自您签收日起7日内,本产品出现《产品性能故障表》所列性能故障的情况,经由本司售后服务中心检测确定,可免费享受退货或换货服务;
- 2、自您签收日起8-15日内,本产品出现《产品性能故障表》所列性能故障的情况,经由本司售后服务中心检测确定,可免费享受换货或维修服务;
- 3、由您签收日起至保修期结束,本产品出现《产品性能故障表》所列性能故障的情况,经由本司售后服务中心检测确定,可免费享受维修服务。

提示信息

因运输过程中需用包装箱保证产品运输安全,建议自签收日起至少保留包装箱30天。

非保修条例

- 1、未经授权的维修、误用、碰撞、疏忽、滥用、进液、事故、改动、使用非本产品配件,或撕毁涂改标签、防伪标记;
- 2、已超过三包有效期;
- 3、因不可抗力造成的破坏;
- 4、不符合《产品性能故障表》所列性能故障的情况;
- 5、因人为原因导致非本产品及其配件产生《产品性能故障表》所列性能故障。

警告

- 请勿尝试拆卸或更换仪器内部零件,如需服务请联系代理商或官方客服。
- 请勿将仪器放置于热源或直接暴露在炉火旁。
- 若任何液体不小心进入仪器,请立即关闭仪器电源。
- 本产品及内部零件,如被儿童误食可能导致窒息等危险。

性能故障表

名称	性能故障
分光测色仪	1、电源指示灯不亮(电池没电除外); 2、仪器开关卡滞,不能正常开关; 3、仪器显示器无法正常显示; 4、测量光源不亮; 5、蓝牙无法连接。

Spectrophotometer Operation Instruction

Product introduction

Please read this manual carefully before using the product.

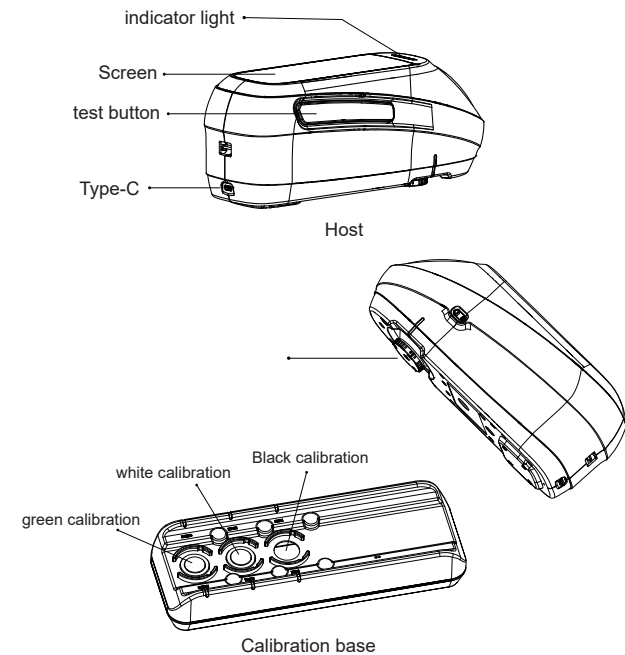

Quick Start

1. Power on and Calibration

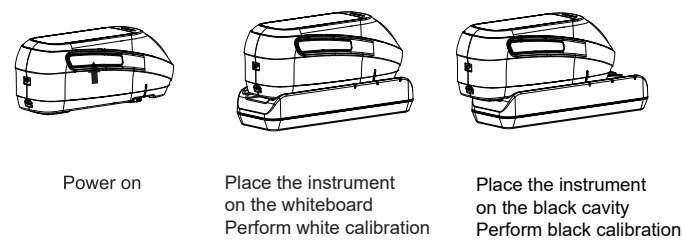

2. How to measure color difference

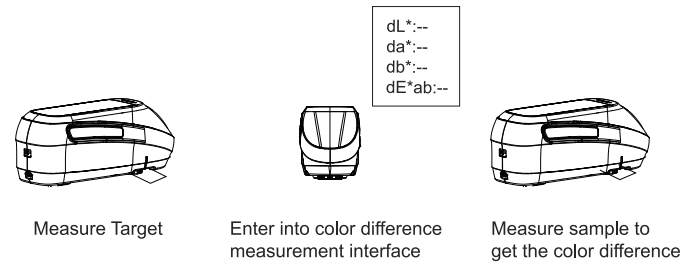

3. Switch Aperture

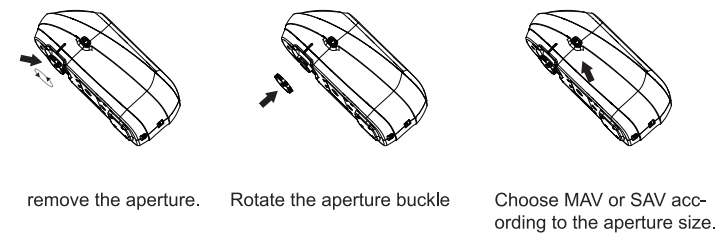

4. Power off

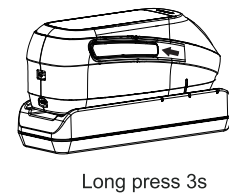

Parameters

NetProf network calibration	support
Measurement structure	D/8,SCI+SCE
SCI+SCE simultaneous measurement	support
Integrating sphere diameter	40mm
lighting source	Full-band balanced LED light source + xenon lamp
sensor	Dual column high-precision CMOS array sensor
Calibration method	BCRA certified black and white board energy calibration, green board wavelength accuracy calibration
Spectral method	grating
Display accuracy	0.01
Light source life	10 million times
Wavelength range	360-780nm
wavelength interval	10nm
Reflectivity measurement range	0-200%
Reflectance resolution	0.01%
caliber	Φ11mm,Φ10mm,Φ6mm,Φ3mm
Aperture Repeatability	dE*ab≤0.01
inter instrument apreement	dE*ab≤0.2
UV light source	yes
view angle	2°, 10°
Light source conditions	A,B,C,D50,D55,D65,D75F1,F2,F3,F4,F5,F6,F7,F8,F9,F10,F11,F12CW-F,U30,U35,DLF,NBF,TL83,TL84,ID50,ID65,LED-B1,LED-B2,LED-B3,LED-B4,LED-B5,LED-BH1,LED-RGB1,LED-V1,LED-V2
Color space	Spectral reflectance, CIE-Lab, CIE-LCh, HunterLab, CIE-Luv, XYZ, Yxy, RGB color difference (ΔE*ab, ΔE*cmc, ΔE*94, ΔE*00), whiteness (ASTM E313-00, ASTM E313-73, CIE, ISO2470/R457, AATCC, Hunter, TaubeBerger Stensby), yellowness (ASTM D1925, ASTM E313-00, ASTM E313-73) blackness (My, dM), stain fastness, color fastness, Tint (ASTM E313-00) color density CMYK (A, T, E, M), metamerism index Milm, Munsell, hiding power, strength (dye strength, tinting power)
measure time	about 1 second
storage	Instrument: 10,000 samples; APP: Mass storage
battery capacity	Can continuously measure 8000 times on a single charge, 7.2V/3000mAh
measurement observation method	Camera
Screen	Full color screen, 3.5 inches
language	Simplified Chinese, English
interface	USB, Bluetooth
calibration	Intelligent automatic calibration
software support	Android, iOS, Windows, WeChat applet
Accuracy guaranteed	Guarantee first-level measurement qualification
Standards compliant	CIE No.15,GB/T 3978,GB 2893,GB/T 18833,ISO7724-1,ASTM E1164,DIN5033 Teil7
size	233mm*77mm*93mm
weight	About 600g

※ Diffuse lighting/8° direction reception, including specular reflected light/removing specular reflected light
 ※※ After whiteboard calibration, measure the whiteboard 30 times at 5-second intervals and measure the standard deviation of the results with MAV caliber.
 ※※※ The average of the MAV caliber measurement values of 12 color plates in the BCRA series

Reminder

It is recommend that keep the packing box for at least 30 days as the packing box is required to ensure the safety of transportation.

Non warranty regulations

- 1.Unauthorized repair,misuse,accident,modification,use of nonofficial accessories.
- 2.Instrument is out of warranty.
- 3.Damage caused by force.
- 4.Not the performance failure listed in the product performance failure table.
- 5.Performance failure caused by human factors.

Warning

- .Do not attempt to disassemble or replace any part of the equipment. Please contact the agent or official customer service for after sales service.
- .Do not place the equipment near heat source or directly expose to the fire.
- .If any liquid enters the equipment,please power off the equipment immediately.
- .This product contains small parts.It may cause suffocation and other hazards,if swallowed by children.

Troubleshooting Table

Name	Performance failure
Spectrophotometer	<ol style="list-style-type: none"> 1.The equipment can't power on. 2.The equipment's button can't work normally. 3.Equipment screen fails to work normally. 4.Equipment lamp fails to work normally. 5.Bluetooth can't connect.